



CNC Foam Cutting Machines  
[www.foamlinx.com](http://www.foamlinx.com)

Welcome to Our Online Catalog

# Content

# Page#

## Introduction

Machines Applications .....	3-7
CNC Hot Wire Foam Cutters .....	8-14
FC2912 (Small Machine).....	8
FC3920 (Medium Machine) .....	9
FC5539 (Medium Machine) .....	10
FCX448 (Large Machine) .....	11
FCX848 (Large Machine) .....	12
SC5542 Foam Sign Cutter .....	13
Custom Foam Cutters .....	14
Laser Cutters and Engravers .....	15
Molding Systems .....	16-17
EPS Foam Compactor .....	18
EPS Foam Shredder .....	19
Polyurethane Shredder .....	20

Foamlinx LLC Machines can be applied in various industries, making any project a cost-effective one, shortening production time and taking off the pressure of deadlines.

Here are some examples of the industries using our machines

## Architecture, Building & Construction

As most architectural features are made of foam that is either molded or coated with concrete, the need for fast and accurate CNC wire foam cutting machines is obvious. Foamlinx machines will allow you to cut any shape fast and accurate, from crown moldings, casting wall caps and columns to EPS and XPS Sandwich Panels for Roofing, EIFS and SIPS. In fact, with our machines or our EPS Foam Factories you can now design and build a whole house.

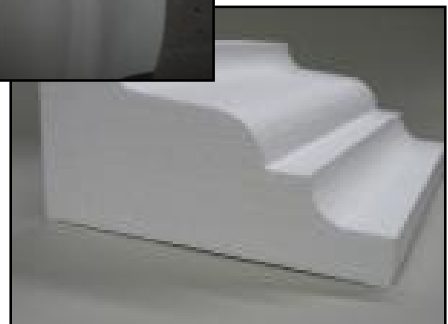
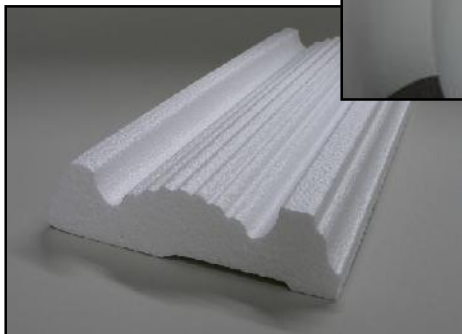
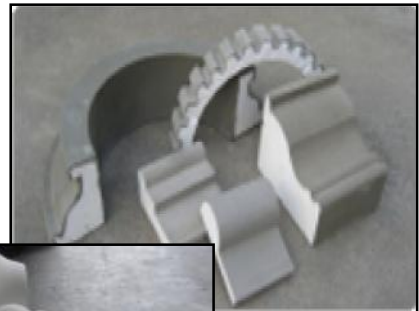
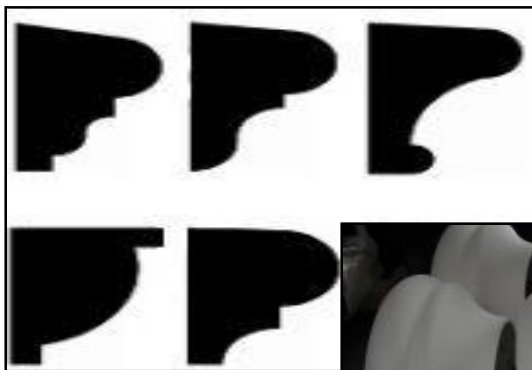

## Monument Signs, 3D Signs & Logos

With our CNC Foam Cutters or our Laser Cutters, we make 3D foam interior and exterior signs, monument signs for displays and for trade shows, wall plaques, statues, foam logos, letters and numbers. Wherever your imagination will take you – we can make it. Just send us your design and we will provide you with a quote.



## RC, Wings and Airfoils

Ever looked at people flying RC planes and wonder how those wings are cut? Well, that's how we started our business, and that is what we specialize in. Foamlinx can cut wings and airfoils of any model airplane, assisting any RC flyer enthusiast with his hobby. We also produce RC models of trains, tanks, helicopters, ships, you name it.

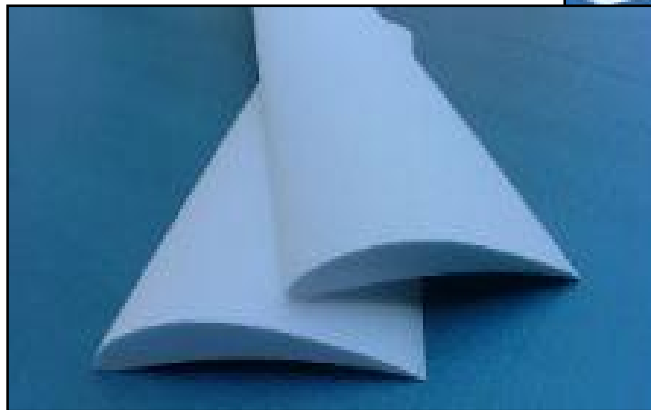

## Props, Prototypes and Displays

Foamlinx manufactures hot wire CNC foam cutters and CNC router systems for producing props for theme parks, museums exhibits, trade shows and displays, parades, theaters and movies, outdoor sculptures, billboards, retailers and any other entertainment industry. We also manufacture foam prototypes for testing and pre-production.

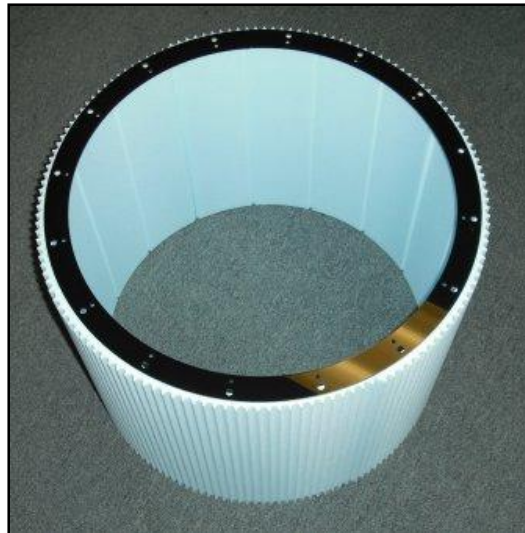
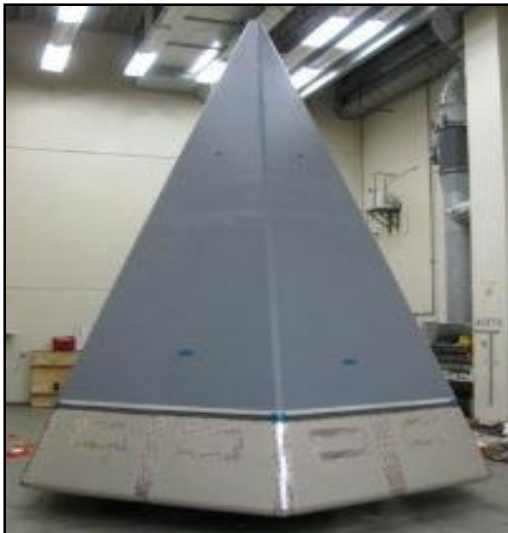



## Packing, Cases and Modelers

Foamlinx customize any packaging design to fit your products. From product cases, to case modelers and foam inserts. Our design will protect your product and keep it safe.

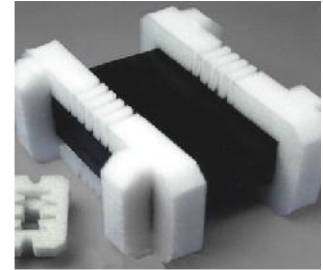

## Aeronautical, Mechanical and Architecture Departments in Universities

We have sold many CNC Hot Wire Foam Cutters to universities in the U.S. and all around the world.

Among them you will find Cal Poly, NC

State, MIT, SCU, Purdue, Naval Academy, University of Alberta Canada, Brunel West University London, Ghent University Belgium and many more.



## 3D Topographic Maps

We can cut or machine 3D topographic maps, up to 10' x 5' x 20" in a single cut. We will scale it, machine it, route it and coat it, making it an artwork masterpiece

## Canoes, Kayaks, Boats and Paddleboards

We have made numerous concrete canoe molds for universities all around the U.S. We either machine a 3D male or female mold with one of our CNC routers, or we cut ribs with our CNC Hot Wire Foam Cutter, glue and sand it into a canoe shape.

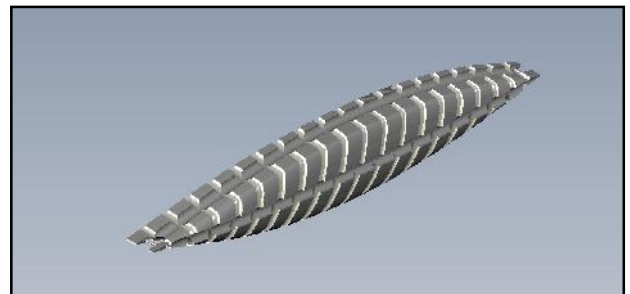

## FC2912 29" x 12" x 50" - CNC Hot Wire Foam Cutter

The FC 2912 Automatic CNC Hot Wire Foam Cutter is a 4 independent axis foam cutter. It is a light machine that can be stored away when not in use.

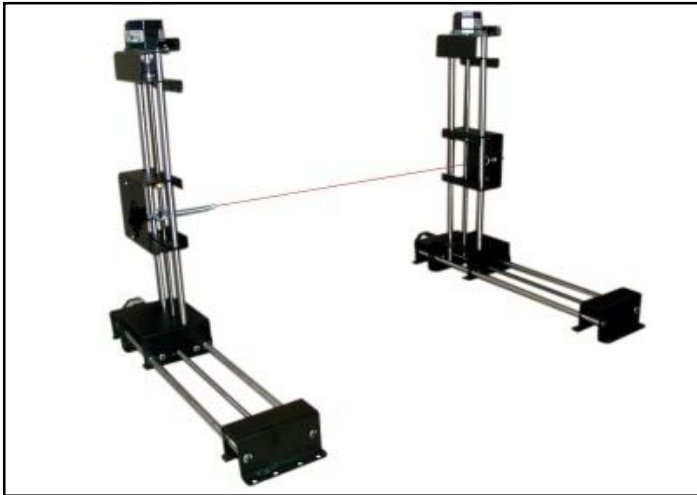

### Specifications

29" effective cutting on the X axis (horizontal)  
12" effective cutting on the Y axis (vertical)  
40" wire length  
0.5" ground and polished steel rod assembly  
1000W hot wire power supply will heat up to 6 feet of wire.

### Speed and Accuracy

Machine accuracy is 0.01", with cutting speed of about 16" per minute. The true 4 axis allows cutting of tapered shapes, where one side is different than the other – tapered wings and columns. The machine includes 4 independent stepper motors with high torque of 220oz inches and NEMA23.

### System Requirements

Power: 110V single phase with 1000W max.  
Comes fully tested and assembled, with electronic box, cables, and motors. Assembly time is about 3 hours and no soldering or drilling is required. It is designed to work with software such as FoamWorks, Mach3 and KCAM (software needs to be purchased separately)



## FC3920 39" x 20" x 70" - CNC Hot Wire Foam Cutter

The FC3920 Automatic CNC Hot Wire Foam Cutter is a 4 independent axis foam cutter. It is a light weight machine that can be stored away once not in use.



### Specifications

39" effective cutting on the X axis (horizontal)  
20" effective cutting on the Y axis (vertical)  
70" wire length  
0.75" ground and polished steel rod assembly  
1000W hot wire power supply will heat up to 8 feet of wire.

### Speed and Accuracy

Machine accuracy is 0.01", with cutting speed of 25" per minute and a cutting wire of 300 feet included.

The true 4 axis allows cutting of tapered cuts, where one side is different than the other.

The machine includes 4 independent stepper motors with high torque of 220oz inches -NEMA23 size motor.

### System Requirements

The machine requires 110V single phase with 300W max.

Comes fully tested and assembled, with electronic box, cables, and motors and assembly manual.

The assembly time is about 3 hours and no soldering or drilling is required. It is designed to work with FoamWorks software (needs to be purchased separately).

## FC5539 55" x 39" x 100" - CNC Hot Wire Foam Cutter

The FC5539 Automatic CNC Hot Wire Foam Cutter is a 4 independent axis foam cutter.

It is a light weight machine that can be stored away once not in use.



### Specifications

55" effective cutting on the X axis (horizontal)  
39" effective cutting on the Y axis (vertical)  
100" wire length  
0.75" ground and polished steel rod assembly  
1000W hot wire power supply will heat up to 8 feet of wire.

### Speed and Accuracy

Machine accuracy is 0.01", with cutting speed of 30" per minute and a cutting wire of 300 feet included.

The true 4 axis allows cutting of tapered cuts, where one side is different than the other.

The machine includes 4 independent stepper motors with high torque of 220oz inches NEMA23 motor size.

### System Requirements

The machine requires 110V single phase with 300W max.

It comes fully tested and assembled, with electronic box, cables, and motors and assembly manual.

The assembly time is about 3 hours and no soldering or drilling is required  
Cutting software is included – Mach3 for 4 axis hot wire CNC foam Cutters.

## FCX448 CNC Hot Wire Foam Cutters



The FC448 is a true 4 axis foam cutter that can cut tapered cuts. The machine is designed to cut 4x4x8 blocks of foam. It can cut EPS (Expanded Polystyrene), XPS foam (Extruded Polystyrene) and EPP foam. It is a heavy duty machine designed to cut a single foam block and can easily handle a 24 continuous operation. The FC448 comes with a PC WinXP computer with the CAD cutting software pre-installed and with over 200 sample shapes to cut.

### Applications

The FC448 can be used for cutting architectural products, for packaging modelers, theme parks, and aeronautical departments in universities.

### Specifications

4 feet effective cutting on the X axis (Horizontal)  
4 feet effective cutting on the Y axis (vertical)  
9 feet wire length.



The machine comes with 2 wires (can be upgraded to 3 wires) and a built in table in which the foam is placed. Also supplied is a hot wire power supply, 1500W that will heat up to 9' of wire.

### Speed and Accuracy

Machine accuracy is 0.01", with cutting speed of 40" per minute, Jog speed of 100" per minute, and a cutting wire of 300 feet included.

### System Requirements

The machine requires 110V single phase with 1500W max. A 6 wire machine version is also available at 220V with 3500W max.

It comes fully tested and assembled, with electronic box, cables, and motors and assembly manual.

The assembly time is less than 1 hour and no soldering or drilling is required  
Comes with computer and software (CAD + G Code Generator)

## FCX848 CNC Hot Wire Foam Cutters



The FC848 Automatic CNC Hot Wire Foam Cutter is a true 4 axis foam cutter that can cut tapered cuts. The machine is designed to cut two 4x4x8 foam blocks side by side or a single block on its 8' length (for long cuts like a surfboard). The FC848 comes with PC - WinXP, CAD tool and cutting software. Also included are 200 pre-drawn shapes ready to cut.

### Applications

The FC848 can be used for cutting architectural products, for packaging modelers, theme parks, and aeronautical departments in universities.

### Specifications

8 feet effective cutting on the X axis (Horizontal)

4 feet effective cutting on the Y axis (vertical)

9 feet wire length.

The machine comes with 2 wires (can be upgraded to 3 wires) and a built in table in which the machine is placed. Also supplied is a hot wire power supply, 1500W that will heat up to 9' of wire.

### Speed and Accuracy

Machine accuracy is 0.01", with cutting speed of 40" per minute, Jog speed of 100" per minute, and a cutting wire of 300 feet included.

True 4 axis allows cutting tapered cuts, where one side is different than the other.

### System Requirements

Power: 110V single phase with 1500W max. A 6 wire machine version is also available at 220V with 3500W max.

It comes fully tested and assembled, with electronic box, cables, and motors. The assembly time is less than 1 hour and no soldering or drilling is required. Comes with computer and software (CAD + G Code Generator)

## SC5542 CNC Hot Wire Foam Sign Cutter

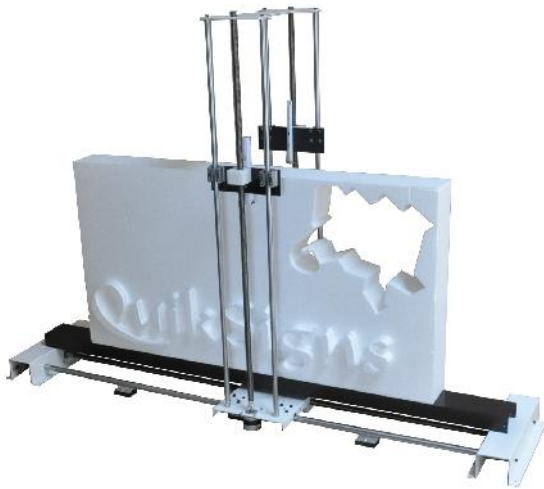

The SC5542 is a true 4 axis foam sign cutter that can cut tapered cuts.

The machine is designed especially for the sign industry, for cutting signs, logos and letters.

The sign cutter will cut 55"x42" sheets of foam, 9" thick

It can cut EPS (Expanded Polystyrene), XPS foam (Extruded Polystyrene) and EPP foam.

It is a light duty machine that can easily be stored when not in use.

The SC5542 comes with a PC computer and monitor and with the CAD cutting software pre-installed.

### Applications

The SC5542 can be used for cutting signs, letters and logos and for architectural shapes.

### Specifications

4.5 feet effective cut on the X axis (Horizontal) 3.5 feet effective cutting on the Y axis (vertical)

9" foam sheet thickness.

The machine comes with computer, monitor, cutting software installed, 1 wire and 20 feet extra wire. Also supplied is a digital hot wire power supply with digital voltage and current reading.



### Speed and Accuracy

Machine accuracy is 0.01", with cutting speed of 30" per minute and a cutting wire of 300 feet included.

### System Requirements

The machine requires 110V single phase with 300W max.

It comes fully tested and assembled, with electronic box, cables, and motors.

The assembly time is less than 30 minutes and no soldering or drilling is required. Comes with computer and software (CAD + G Code Generator)

## Custom CNC Hot Wire Foam Cutters



Custom machinery is our specialty. We design custom foam cutters for EPS, XPS, EPP, and Polyurethane foam as well as foam slicers, large scale laser cutters and router systems. We also design combination of CNC hot wire foam cutters with routers in any size needed, some larger than 25' x 9'.





## Laser Cutters and Laser Engravers

Our laser cutters and engravers deliver a high laser cutting performance on a wide variety of materials, including foam, acrylic, coroplast, wood, marble, granite, glass and plexiglass.

The laser machines will cut or engrave any design from any graphic software into the material. The end result is an art work that is very precise and clean look.

The laser cutter is especially designed to produce architectural models from materials such as plastics, acrylic, wood, and fiberglass.

It is the perfect solution for production of packaging inserts and cushioning, tool trays, 3D shapes, props

The laser engravers are a high end solution to producing corporate logos and ads or any custom advertising project. The result is a piece of art.



Whether you are starting a small business in the laser cutting and engraving industry, or you are looking to advertise your business through engraving your logo, Foamlinx has the perfect laser machine to suit your needs.



## EPS and EPP Molding Systems

Foamlinx provides a turnkey solution for foam factories by supplying EPS foam molding systems. Those factories are mostly suitable for the building and construction industry since they provide solution for SIPS and panels manufacturing.



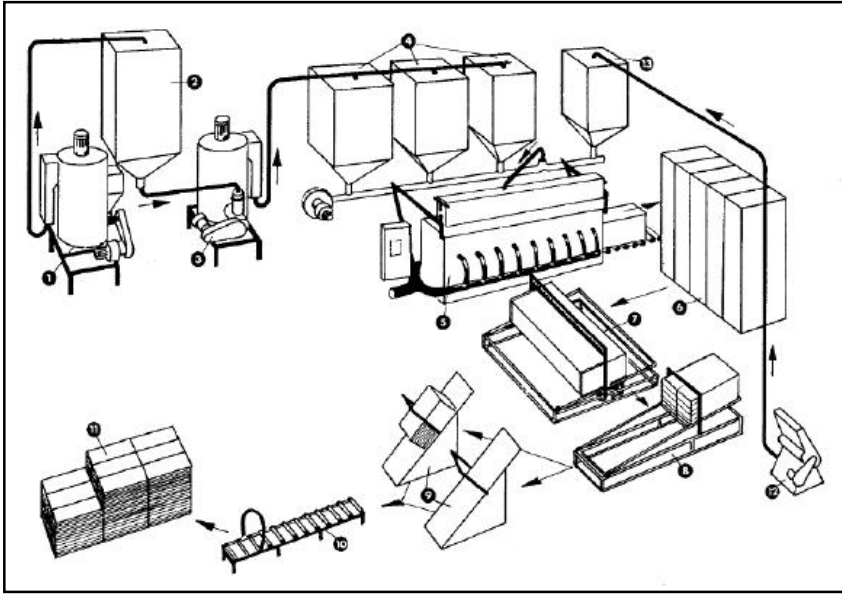

We tailor each factory according to the customer's needs, from the floor plan all the way to the full scale manufacturing and production, while supplying installation and set-up, training and full customer support. We pay attention to all details, including boilers, steam tanks, controllers, compressor and other components needed for the factory to run smoothly, thus saving time and money.



---

[www.foamlinx.com](http://www.foamlinx.com) Tel: 408-454-6163 Fax: 408-212-8348

## EPS Foam Compactor

Keep the environment green and recycle scrap EPS, XPS, EPP and Polyurethane (PU) foams. Compacted EPS foam blocks will only take 2-5% of the original space and you will be able to stack them one on top of another. The compactor will achieve a density of 180kg-250kg/m<sup>3</sup>, while working with dirty or wet EPS material.



## EPS Foam Shredder

The machine will shred EPS foam from 1LB to 2.5LB foam densities to small beads, about 0.35".

The machine will shred EPS foam densities of 1 to 2.5LB into small beads. You will then be able to use that shredded foam by mixing it with cement for building, using it as stuffing to bean cushions, or placing it into beanie babies and other toys for green use



## PU Foam Shredder

The machine will shred Polyurethane foam densities of up to 4LB into small pieces, 3-20mm shred size. Shredder capacity is 66LB/hr, 4KW. Machine dimensions are 20"x20"x52", net weight 180LB. The shredded polyurethane foam can be used to fill cushions, bean bags and toys.

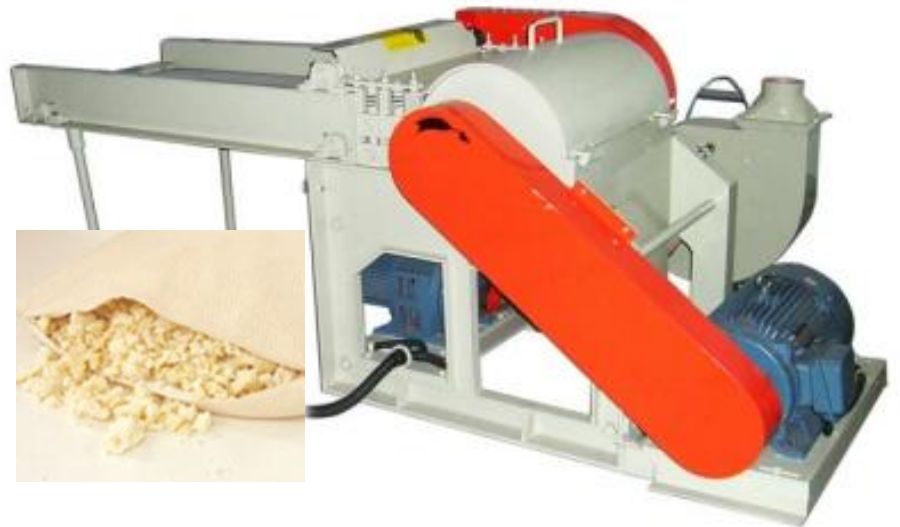



Coating Machine

COMING SOON